

Water Supply (Water Fittings) Regulations 1999

GUIDANCE NOTES FOR DOMESTIC PLUMBING SYSTEM

Information for anyone installing,
modifying or maintaining domestic
plumbing systems

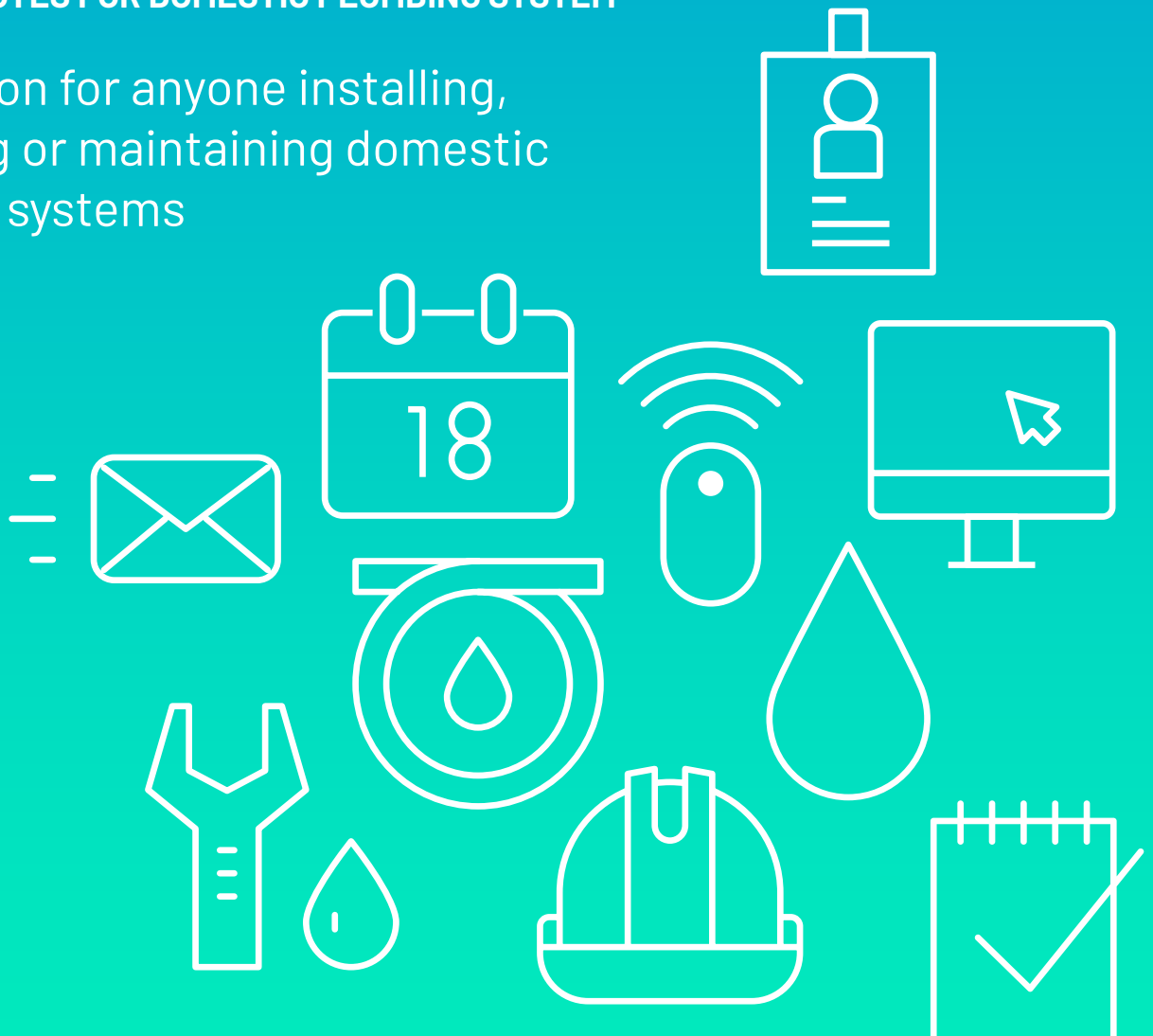

Contents

1.0	External pipework	4
1.1	Pipe entry to premises	4
1.2	Depth of pipe underground	4
1.3	Pipe material	5
1.4	Outside tap	5
1.5	Insulation and protection	6
1.6	Connection to other supplies	6
1.7	Ponds and swimming pools	7
1.8	Metered external bid tap installation	7
2.0	Internal pipework	9
2.1	Fixing of water fittings	9
2.2	Location of pipes and fittings	9
2.3	Stop valve to premises	9
2.4	Provision of draining taps	9
2.5	Provision of servicing valves	9
2.6	Drinking water tap	9
2.7	Mixer taps	10
2.8	Washing machine/dishwasher points	11
2.9	Water softener	11
2.10	WC cistern flush capacity	11
2.11	WC Warning pipes	11
2.12	Submerged inlets to baths and washbasins	12
2.13	Shower hose	12
2.14	Bidet	12
2.15	Unvented hot water system	13
2.16	Hot water services	13
2.17	Feed and expansion cistern	13
2.18	Cold water storage cistern	14
2.19	Closed circuits	15
3.0	General requirements	17
3.1	Pressure testing	17
3.2	Flushing	17
3.3	Disinfection	17
3.4	Notification of works	18



On 1st July 1999 Water Suppliers in England and Wales ceased to enforce their own Water Byelaws and instead, began enforcing the new Regulations* of the Secretaries of State of England and Wales, or the 'Regulator' as referred to in the Regulations.

*** The Water Supply (Water Fittings) Regulations 1999**

This booklet is designed to provide guidance on the most common aspects of the regulation for domestic plumbing arrangements.



Section one: External pipework



1.0 External pipework

1.1 Pipe entry to premises

SCHEDULE 2.3.7

Pipes entering buildings at the approved depth should be passed through a duct and the ends of the duct sealed to prevent the ingress of gas or vermin into the building.

See details 1, 2 and 3

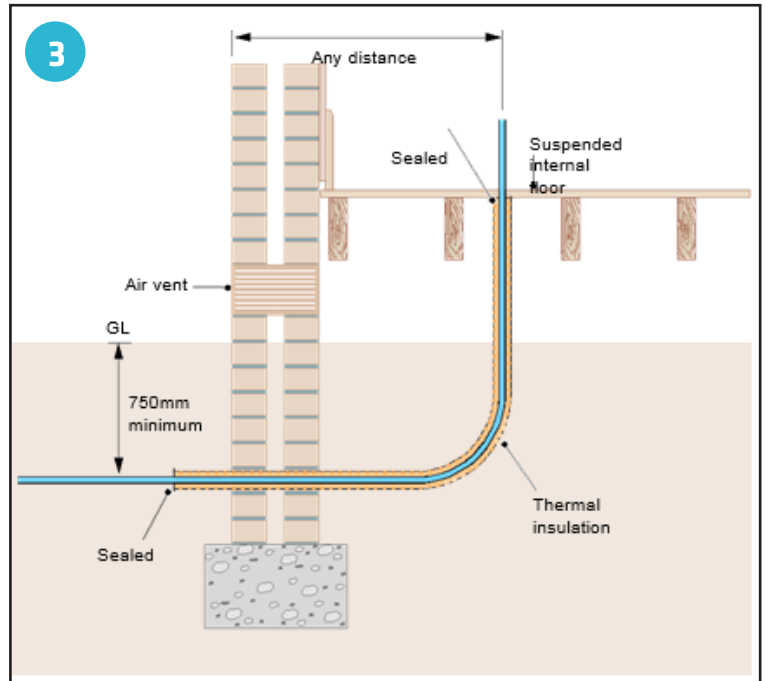
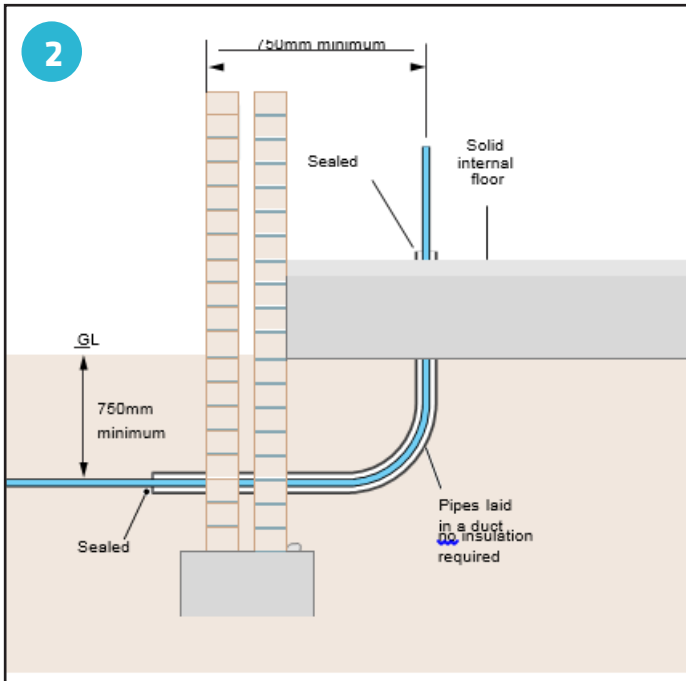
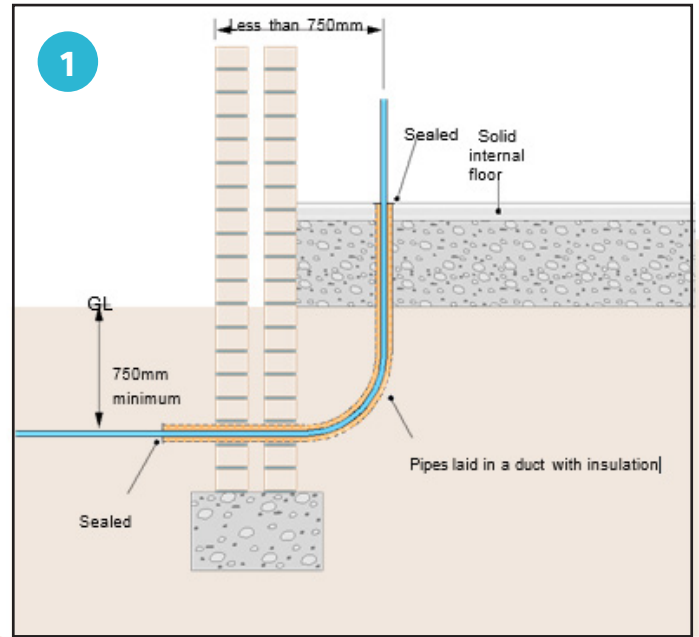

1.2 Depth of pipe underground

SCHEDULE 2.3.7

Not less than 750mm, not more than 1350mm, unless in a duct.

See detail 4

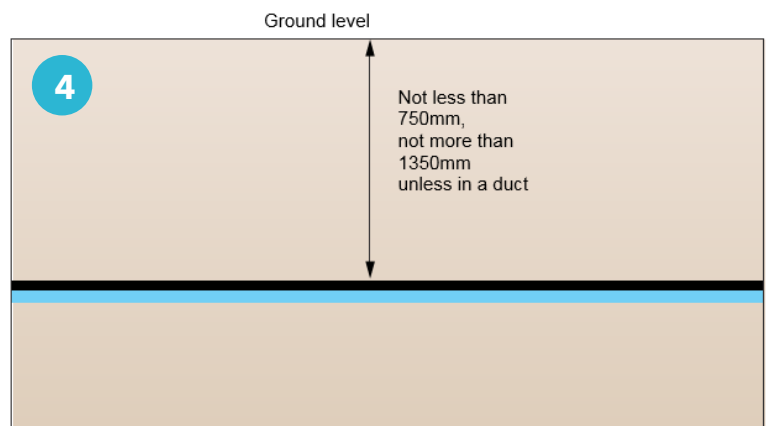

1.3 Pipe material

SCHEDULE 2.2

Materials or substances, either alone or in combination, which cause, or are likely to cause, contamination of water should not be used in the construction, installation, renewal, repair or replacement of any water fitting which conveys or receives water supplied for domestic or food production purposes. Particular materials unsuitable for use in contact with water intended for domestic or food production purposes include lead and bitumastic coatings derived from coal tar.

Lead pipe is prohibited for use in new installations (this includes lead solders).

Pipes of different metallic materials are not to be connected unless suitable precautions are taken to ensure that corrosion through galvanic action cannot take place.

Water fittings should be adequate for the purpose and satisfy the appropriate British Standard, or acceptable equivalent.

POLYETHYLENE PIPES: BS 6572:

Blue polyethylene pipes up to nominal size 63mm for below ground use for potable water. BS 6730: Black polyethylene pipes up to nominal size 63mm for above ground use for cold potable water.

UNPLASTICISED PVC PIPES: BS 3505:

Specification for unplasticised polyvinyl chloride (PVC-U) pressure pipes for cold potable water.

COPPER TUBES: BS EN 1057:

Copper and copper alloys. Seamless, round copper tubes for water and gas in sanitary and heating applications

STEEL PIPES: BS 1387:

Specification for screwed and socketed steel tubes and tubulars and for plain end steel tubes suitable for welding or for screwing to BS 21 pipe threads.

STAINLESS STEEL PIPES: BS 4127:

Light gauge stainless steel tubes, primarily for water applications.

IRON PIPES: BS EN 545:

Ductile iron pipes, fittings, accessories and their joints for water pipelines.

Ductile iron pipes to this standard are manufactured in sizes DN 40 to DN 2000.

Only approved jointing materials are to be used for jointing screwed pipes and fittings. Hemp or gaskin is not to be used for any types of joints in any circumstances.

1.4 Outside tap

SCHEDULE 2.6.15.20

Taps to which hoses are, or may be, connected and located in house garden locations are to be protected against backflow by means of a double check valve.

Double check valves have been shown to be susceptible to frost damage and should therefore be protected against freezing by being installed inside a building, or by other means. [See detail 5](#)

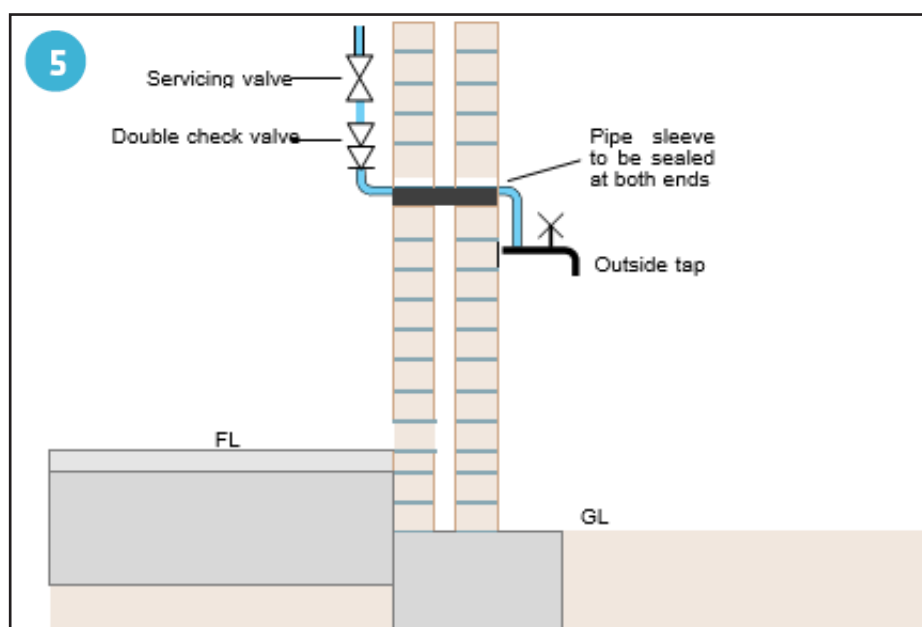

1.5 Installation and protection

SCHEDULE 2.3.4.B(II)

Insulation only delays freezing. All cold water fittings located within the building, but outside the thermal envelope, or those outside the building should be protected against damage by freezing. Insulation also helps to prevent warming in cold water systems, which could lead to bacteriological growth.

Water pipes that are located;

- a. above ground level external to buildings; or
- b. under suspended ground floors; or
- c. in unheated communal staircases, corridors, garages or roof spaces, should be protected with a thickness of insulation that is no less than that recommended in the table.

The thickness of insulation for the protection of cold water cisterns in roof spaces and other exposed locations should be calculated in accordance with BS EN 1057.

Recommended minimum commercial thickness of thermal insulation for copper water pipes of minimum wall thickness complying with BS EN 1057 in normal conditions of exposure.

THERMAL CONDUCTIVITY OF INSULATION MATERIAL AT 0°C IN W/(M.K)					
	0.02	0.025	0.03	0.035	0.04
mm	mm	mm	mm	mm	mm
15	20 (20)	30 (30)	25* (45)	25* (70)	32* (91)
22	15 (9)	15 (12)	19 (15)	19 (19)	25 (24)
28	15 (6)	15 (8)	13 (10)	19 (12)	22 (14)
35	15 (4)	15 (6)	9 (7)	9 (8)	13 (10)
42 and over	15 (3)	15 (5)	9 (5)	9 (5)	9 (8)

1.6 Connections to other suppliers

SCHEDULE 2 5.14(2)

Any pipe conveying rainwater, recycled water or any other water, from a source other than the water undertaker, is not to be connected to any pipe carrying wholesome water supplied by the water undertake.

Except when a suitable backflow prevention device or arrangement is installed in accordance with the requirements of Schedule 2: Paragraph 15 of the Regulations.

This requirement would be satisfied if wholesome water (Fluid category 1) was delivered into a cistern containing greywater (Fluid category 5) providing that the wholesome water was delivered into the cistern through a backflow prevention device or arrangement suitable for protection against a fluid category 5 risk. For example, Type AA, AB or AD air gap.



1.7 Ponds and swimming pools

SCHEDULE 2.12.31

Any pond, fountain or pool filled or supplied with water by the Water Undertaker should have an impervious lining and be watertight.

This requirement only applies to constructed ponds, fountains or pools which have an impervious lining to prevent leakage of

water. Pools etc. constructed of concrete will be accepted if they have been designed, constructed and tested in accordance with BS8007: 1987: Code of practice for the design of concrete structures for retaining aqueous liquids. A pond, fountain or pool may be replenished by automatic means providing the method of backflow protection is by a Type AA air gap.

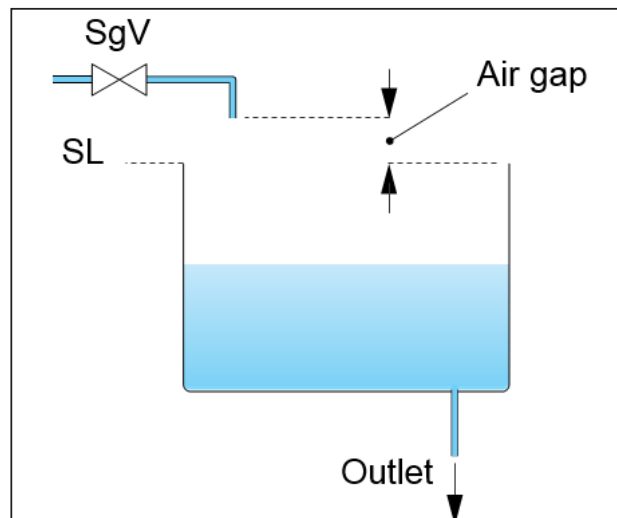

1.8 Metered external bid tap installation

When designing or setting up any external standalone supply (typical use, temporary builders supplies, bin stores, water filling point for garden use) the below diagram shows all the components required prior to connecting to the network.

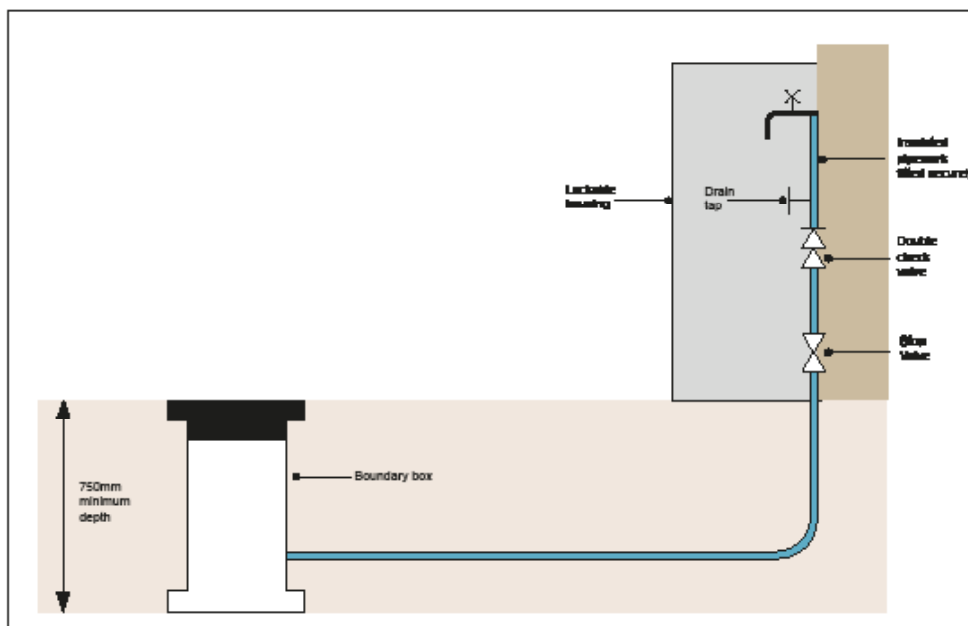

Section two:

Internal pipework



2.1 Fixing of water fittings

SCHEDULE 2.4.18

Water fittings should be adequately supported, the spacing for support being dependent on the material of the pipe. Allowance should be made to accommodate any reasonable foreseeable movement, including thermal movement, in accordance with clause 3.1.7 of BS6700.

2.2 Location of pipes and fittings

SCHEDULE 2.3.7

A concealed pipe and fittings may be installed in a pipe sleeve or duct located under or within a solid floor provided that the pipe and/or fitting can be readily removed and replaced.

Unless located in an internal wall which is not a solid wall, a chase or duct which may be readily exposed, or under a suspended floor which may, if necessary, be readily removed and replaced, or to which there is access, water fittings should not be:

- located in the cavity of a cavity wall; or
- embedded in any wall or solid floor; or
- installed below a suspended or solid floor at ground level.

Note: Any notching or holes made within floor or roof joists should be within the limits shown in Building Regulations, Approved Document A, Section 1B6.)

2.3 Stop valves to premises

SCHEDULE 2.4.10.3

Every supply and distributing pipe providing water to premises should be fitted with a stop valve to control the supply to those premises only. **See detail 6.**

The Water Acts normally require premises to have separate supply pipes wherever this is possible. Where a supply or distributing pipe provides water in common to two or more premises a stop valve should be provided, either inside or outside the premises, to which each occupier has access. The principle is that if any occupiers are suffering damage or nuisance to their premises due to a leaking or defective fitting whether on their own premises or on a common pipe they should have ready access to a stop valve which controls the supply to those premises or fittings. Attention is drawn to the need for the provision of whole site backflow protection where two or more premises are served by a common supply pipe.

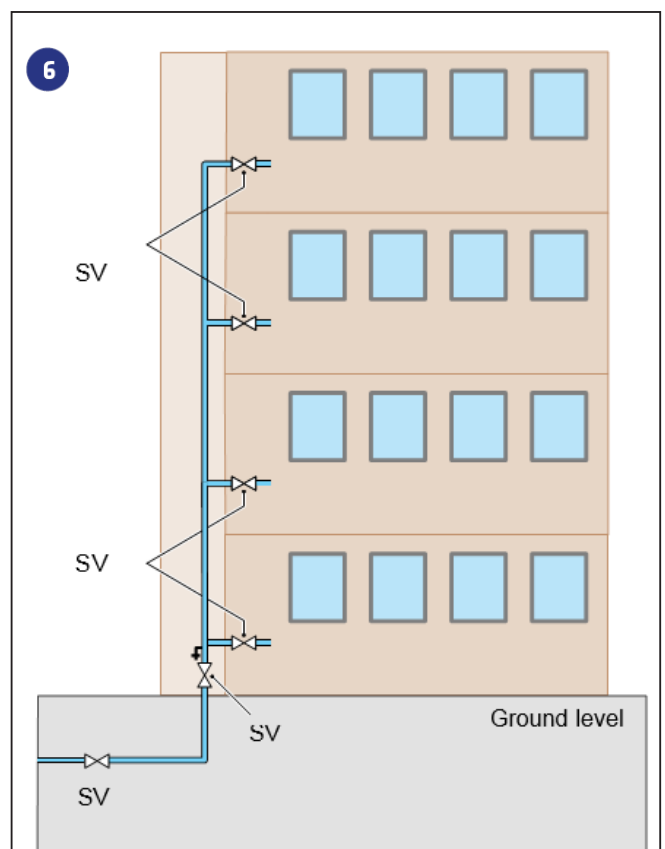

2.4 Provision of draining taps

SCHEDULE 2.3.7

Sufficient draining taps should be provided to facilitate the draining of all supply and distributing pipes within the building. Draining taps should be of the screwdown type conforming to BS 2879 or, where located in a frost free location, of an approved spherical type. They should not be buried or covered with soil, or installed so that they are submerged, or likely to be submerged.

2.5 Provision of servicing valves schedule

SCHEDULE 2. 4.11

Inlets to all float-operated valves, cisterns, clothes washing machines, dishwashing machines, water heaters, water softeners and other similar appliances should be provided with a servicing valve to facilitate maintenance. Servicing valves should be fitted as close as is reasonably practical to float operated valves or other inlet devices of an appliance. Servicing valves may be of the screwdown or spherical type.

2.6 Drinking water tap Schedule

SCHEDULE 2. 10.26

All premises supplied with water for domestic purposes shall have at least one tap conveniently situated for the drawing of drinking water. Which in a house should be located over the kitchen sink and be connected to the supply pipe prior to any water softener.

A drinking water tap shall be supplied with water from:-

- (a) a supply pipe;
- (b) a pump delivery pipe drawing water from a supply pipe; or
- (c) a distributing pipe drawing water exclusively from a storage cistern supplying wholesome water.

2.7 Mixer taps (single/bi-flow)

SCHEDULE 2.15.13

Combination taps with separate waterways do not require any additional backflow protection. However, combination (blending) taps that allow mixing of the water to occur within the body of the tap should have single check valves on the hot and cold inlets. **See detail 7.**

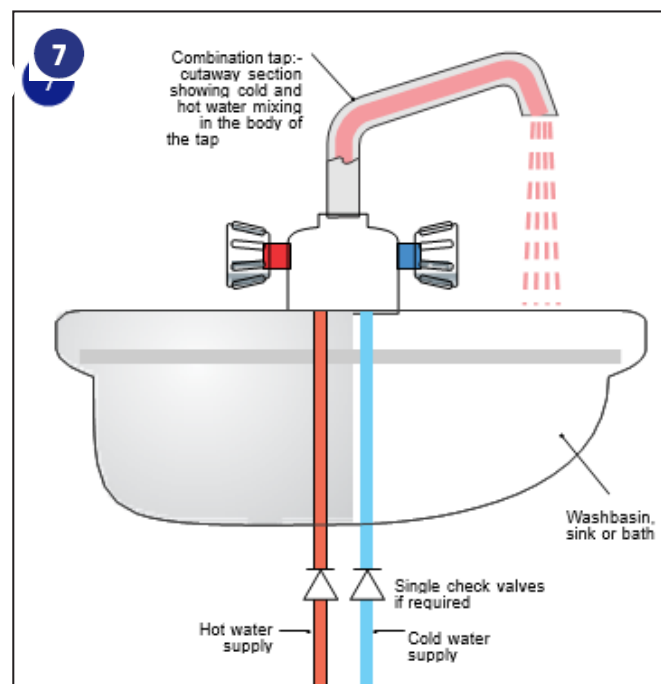

2.8 Washing machine/ dishwasher points schedule

SCHEDULE 2.15.13

Where the connection to dishwashers and washing machines are via non approved flexible hoses, a single check valve should be installed after the servicing valve on the cold inlet.

2.9 Water softener

SCHEDULE 2.26(1)

Domestic softening plant (common salt regeneration) is considered a fluid category 2 and should have a single check valve installed on the inlet to the unit. A drinking water tap should be connected to the supply pipe prior to any water softener. The installation must have provision for the pipework to allow easy bypass of the water softener in the event of malfunction or maintenance.

2.10 WC cistern flush capacity

As from 1st January 2001, no flushing device installed for use with a WC pan shall give a single flush exceeding 6 litres and the lesser volume of water for a dual flush device shall not exceed two-thirds of the largest flush volume. A flushing cistern installed before 1st July 1999 may be replaced by a cistern which delivers a similar volume, but a single flush cistern may not be replaced with a dual flush cistern.

2.11 WC Warning pipes

Except for pressure flushing cisterns, all WC flushing cisterns should be provided with a connection for a warning pipe, the outlet of which is to discharge in a prominent position, or other equally effective device.

The Water Supply Industry considers modern, tested and approved ball valves are sufficiently reliable and that WCs that have an internal overflow discharging into the WC pan shall be deemed to meet the requirement of the Regulations. A warning pipe may also discharge into a flush pipe, without a tundish.



2.12 Submerged inlets to baths and washbasins

SCHEDULE 2.15.13

Submerged inlets to baths or washbasins in any house or domestic situation are considered to be a fluid category 3 and should have double check valves installed on the hot and cold water inlets. See detail 8.

2.13 Shower hose

SCHEDULE 2.15.14

If a sink, WC or bidet is located within the zone of backflow risk of a flexible hose, the cold and hot water supplies to the hose must be protected against a fluid category 5 risk. Please contact IWNL for further information.

Where a hose with a spray jet is served from a tap assembly or mixer fitting located over a wash basin, bath or shower tray, the zone of backflow risk should be ascertained. If the spray or jet on the end of the hose is capable of entering any wash basin, shower tray or bath, a fluid category 3 backflow protection device, such as a double check valve, should be provided on each inlet pipe to the appliance.

See detail 9.

2.14 Bidet

Bidets are considered to be a high contamination risk. Please contact IWNL for further information.

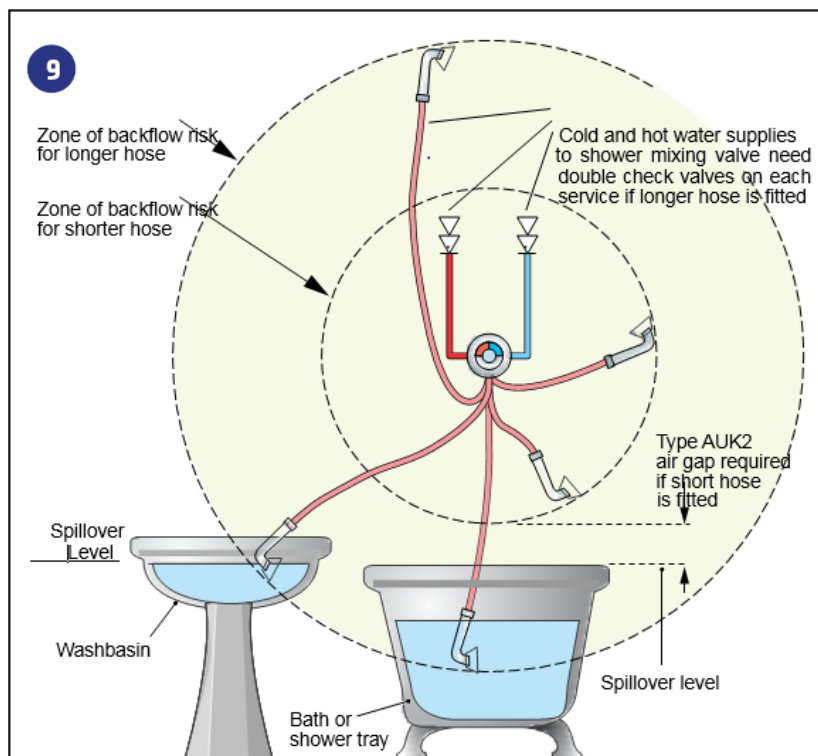
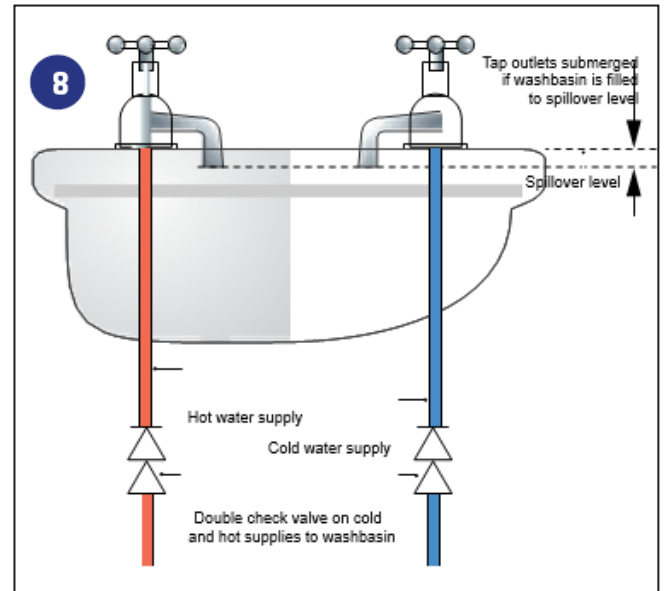

2.15 Unvented hot water system

SCHEDULE 2.17

Every unvented water heater or storage vessel, and every secondary coil contained in a heater and not being an instantaneous water heater or a thermal storage unit of 15 litres or less capacity, should be fitted with:

- a. a temperature control device; and
- b. either a temperature relief valve or combined temperature and pressure relief valve; and
- c. an expansion valve; and
- d. unless the expanded water is returned to the supply pipe in accordance with Schedule 2: Paragraph 15(2)(a), either;
 - (i) an expansion vessel; or
 - (ii) contain an integral expansion system, such that the expansion water is contained within the secondary system to prevent waste of water.

A person who intends to install an unvented hot water system (of more than 15 litres) in existing premises, or carry out building work including an unvented hot water system, must notify the Local Authority under the 1991 Building Regulations for England and Wales.

The unvented system must comply with the relevant requirements of the Regulations and the installer must be a competent person.

2.16 Hot water services

SCHEDULE 2.18

Irrespective of the type of fuel used for heating, the temperature of the water at any point within a hot water storage system should not exceed 100°C and appropriate vent pipes, temperature control devices and other safety devices should be provided to prevent this occurring.

2.17 Feed & expansion cistern

SCHEDULE 221

Every expansion cistern, and every cold water combined feed and expansion cistern connected to a primary or heating circuit, should be capable of accommodating any expansion water from the circuit and installed so that the water level is not less than 25mm below the overflowing level of the warning pipe when the primary or heating circuit is in use. [See detail 10.](#)

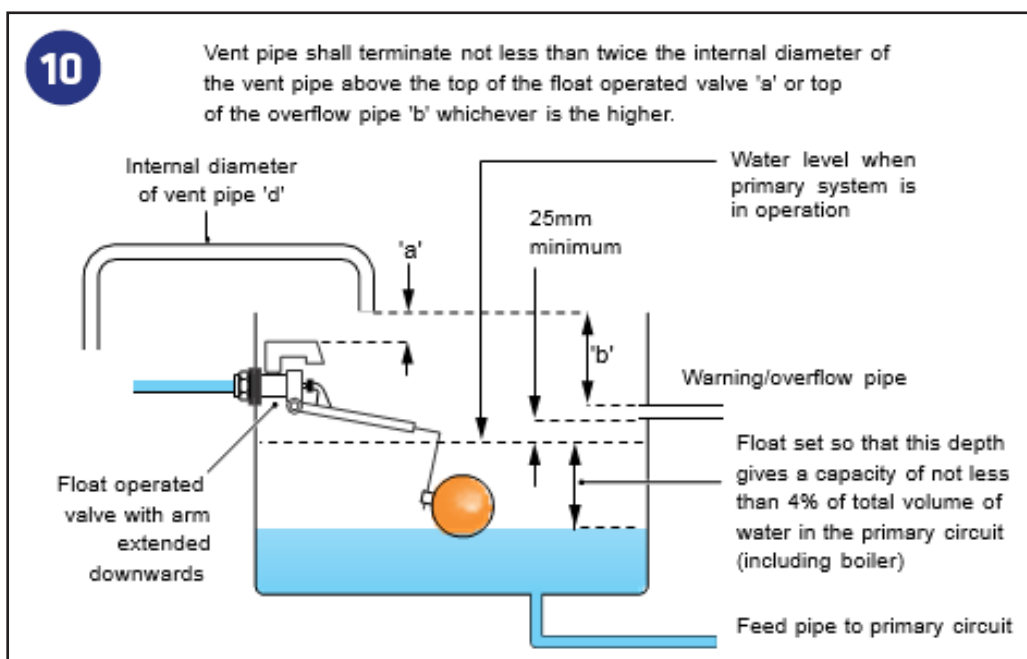

2.18 Cold water storage cistern

SCHEDULE 2.16

Cisterns storing water for domestic purposes should be watertight and, where required, be lined or coated with a suitable impermeable material. They should have a rigid, close fitting and securely fixed cover which is not air tight, but which excludes light and insects. The requirements of clause 16,1 can normally be satisfied in single houses by the use of single piece storage cisterns and covers conforming to BS7181. [See details 11 & 12.](#)

The cistern should be adequately supported to avoid distortion or damage and only installed in a place or position where the inside may be readily inspected and cleansed, and any float operated valve or other controls may be readily installed, repaired, renewed or adjusted. There should be a minimum 350mm unobstructed space above.

The inlet to the cistern should be fitted with a servicing valve as close as reasonably practical to the float operated valve. Where practical the outlet from the cistern should be taken from the bottom of the cistern to prevent the retention of sediment.

Every storage cisterns, except one supplying water to primary circuits of a heating system, shall be fitted with a servicing valve on the outlet pipe lose to the cistern as is reasonably practical.

An adequately sized single overflow/warning pipe should be sufficient for a cistern of 1,000 litres or less actual capacity. It should be screened to exclude insects.

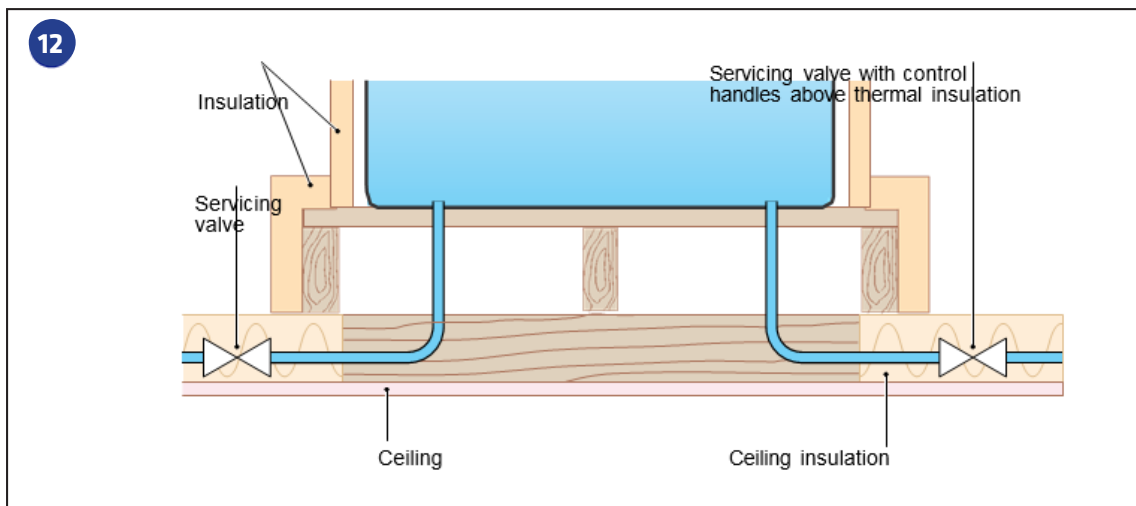
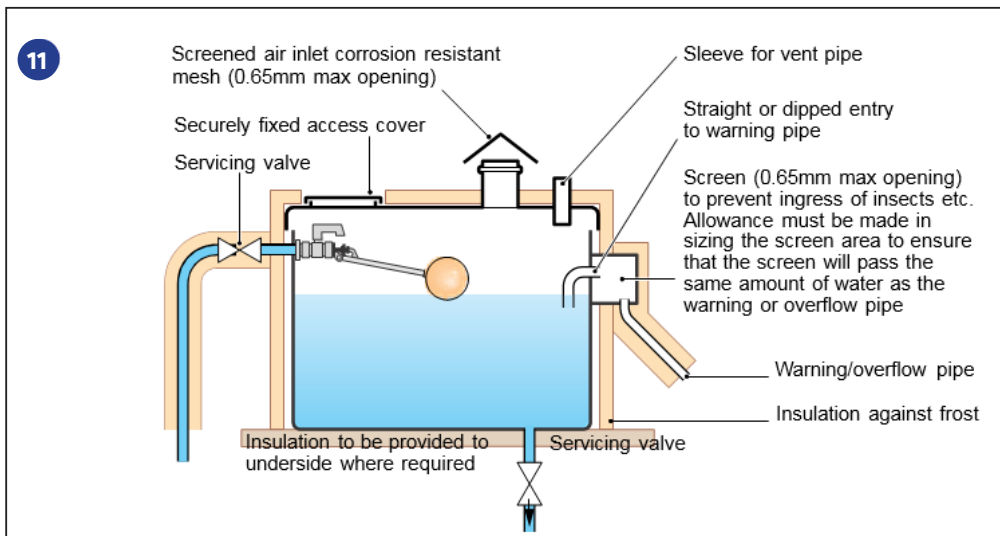

2.19 Closed circuits

SCHEDULE 2.24

Primary and other closed circuits have to be initially filled with water and require additional 'topping-up' at intervals during use. Primary circuits may contain additives and the water can be heavily contaminated, therefore they are not to be permanently connected to any supply pipe without an air break device. **See detail 13.**

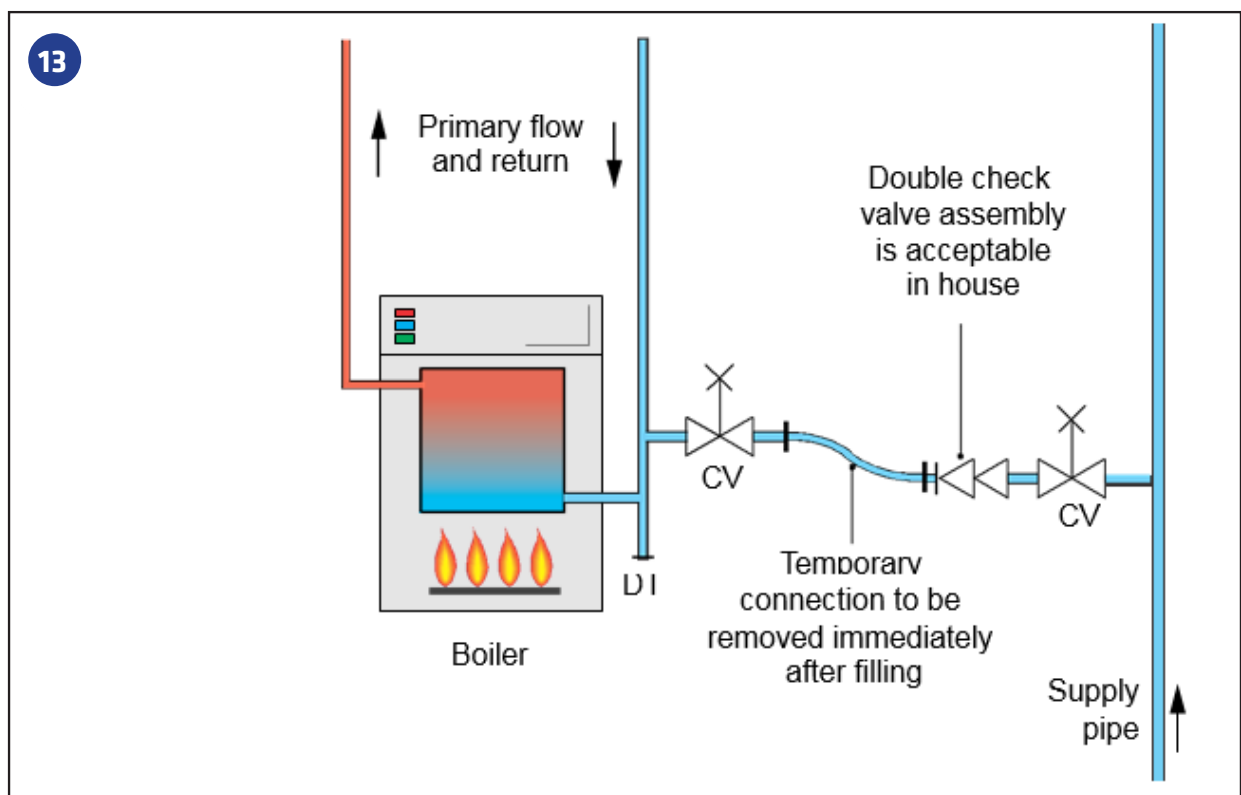

Section three: General requirements



3.1 Pressure test

SCHEDULE 2. 4.12

All water fittings should be capable of withstanding an internal water pressure of not less than 1.5 times the maximum operating pressure.

Both underground and above ground systems of pipework should be subjected to a final test after completion of the installation and after all builders work has been carried out. The final test is crucial but it is advantageous if buried pipework, is tested on an interim basis before being backfilled. In all cases, defects revealed as the result of a test should be rectified and retesting carried out until the result is satisfactory.

3.2 Flushing schedule

SCHEDULE 2. 4.13

Flushing of installations should be in accordance with Clause 3.1.10.1 of BS 6700 : 1997. It is essential that each length of pipe within the system is flushed to remove any debris, including excess flux, that may have collected in the pipework.

3.3 Disinfection Schedule

SCHEDULE 2. 4.13

Pipework & fittings within a new private dwellings and occupied by a single family will not normally require disinfection, unless it is suspected that contamination may have occurred.

It is normally sufficient for the system to be fully inspected and flushed out. Each cistern should be carefully inspected and any deleterious matter removed.

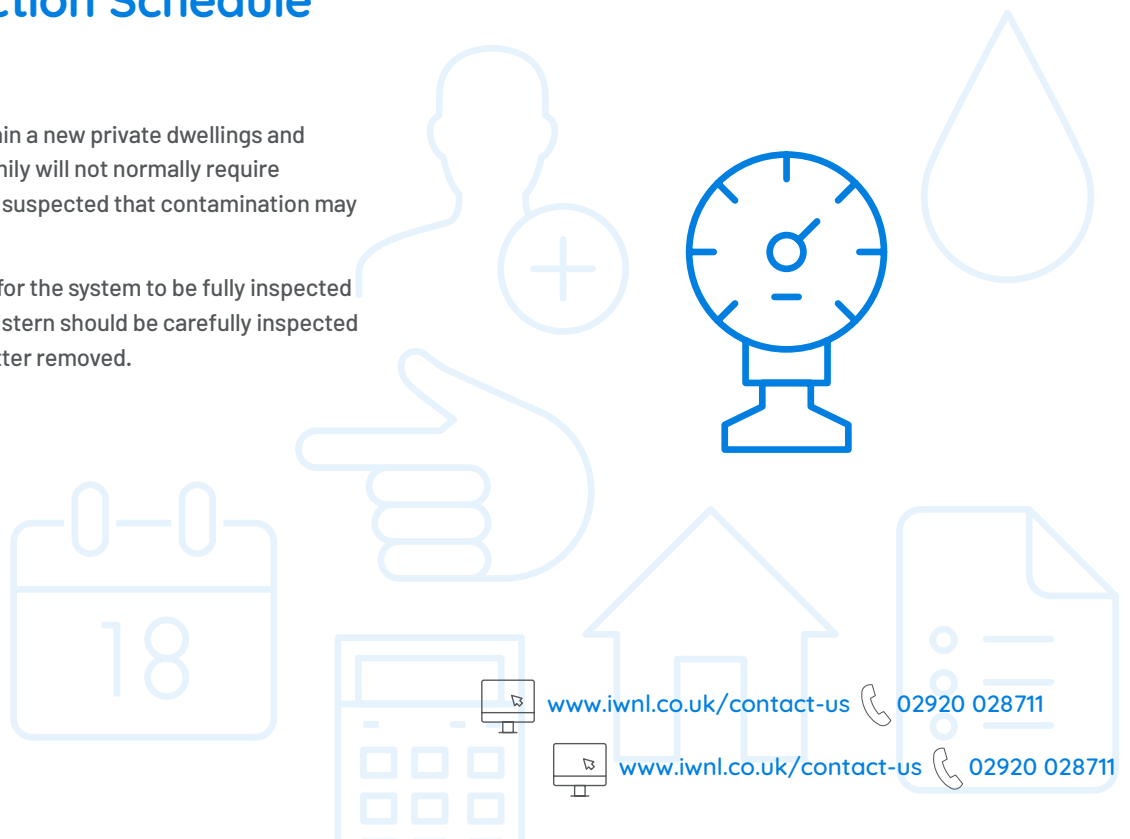

3.4 Notification

In most cases, before work starts on any proposed plumbing installation, the installer, owner or occupier must give notice that he proposes to begin work. If you need a notification form please contact us. The plumbing work for which notification must be submitted is shown in the following table:

THE INSTALLATION OF A WATER FITTING IN CONNECTION WITH:	
1	The erection of a building or structure, not being a pond or swimming pool
2	The extension or alteration of a water system on any premises other than a house
3	A material change of use of the premises
4	The installation of:
4 (a)	A bath having a capacity as measured to the centre line of the overflow, of more than 230 litres.
4 (b)	A bidet with an ascending spray or flexible hose.
4 (c)	A single shower unit that may consist of one or more shower heads within a single unit of a type specified by the Regulator
4 (d)	A pump or booster drawing more than 12 litres per min, connected directly/indirectly to a supply pipe
4 (e)	A unit which incorporates a reverse osmosis
4 (f)	A water treatment unit which produces a waste water discharge or which requires the use of water for regeneration or cleaning.
4 (g)	A Reduced Pressure Zone (RPZ) valve assembly or other mechanical device for protection against a fluid which is in fluid Category 4 or 5
4 (h)	A garden watering system, unless designed to be operated by hand
4 (i)	Any water laid outside a building and either less than 750mm below ground level or more than 1350mm below ground level.
5	The construction of a pond or swimming pool with a capacity greater than 10,000 litres, which is designed to be replenished by automatic means with water supplied by the statutory water supplier.

